

# ABB standard drives

ACS550, 0.75 - 550 Hp

Technical catalog



# Two ways to select your drive

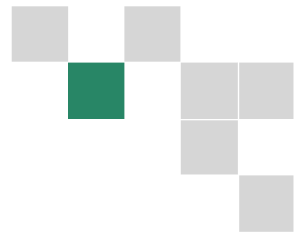

**Choice 1:** Simply contact your local ABB drives sales office and let them know what you want. Use page 5 as a reference section for more information.

**OR**

**Choice 2:** Build up your own ordering code using the simple 7-step approach below and then contact your local ABB Drive Sales Office.

Type code:

ACS550 - U1 - 03A3 - 4 + B055

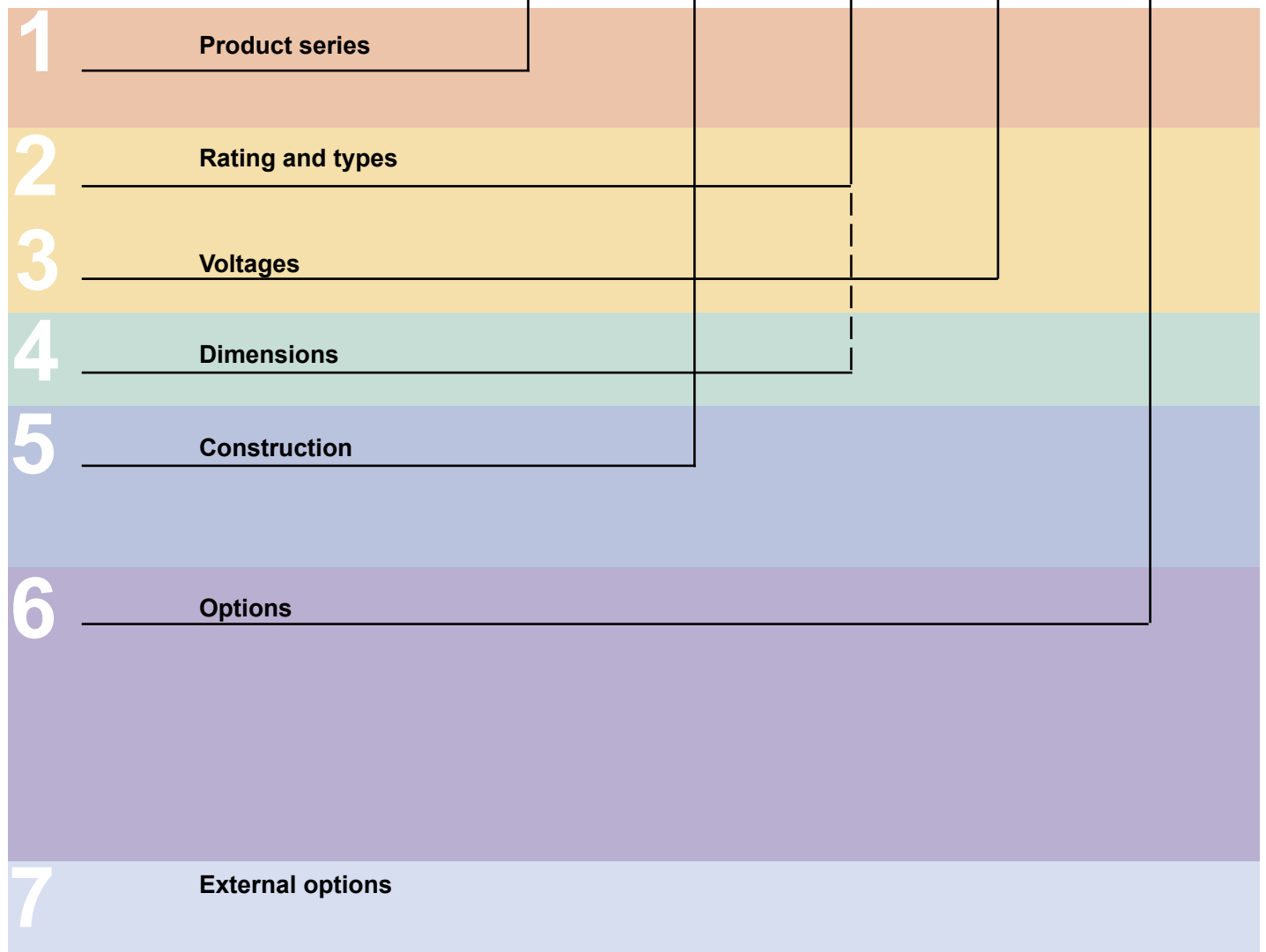

# Contents

## ABB standard drive, ACS550

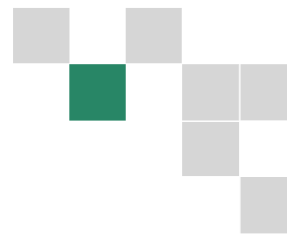

	Page
<b>ABB standard base drive</b> .....	<b>4</b>
<b>Ratings, types and voltages</b> .....	<b>5</b>
<b>Dimensions</b> ..□	<b>6</b>
<b>Construction</b> □	<b>7</b>
<b>Advanced control panel</b> .....	<b>7</b>
<b>Options</b> .....□	<b>8</b>
<b>Control interfaces</b>	
<b>How to select options</b> .....	<b>8</b>
<b>Panel Mounting Kit</b> .....	<b>8</b>
<b>DriveWindow Light 2</b> .....	<b>8</b>
<b>Plug-in options</b>	
<b>Relay output extension option module</b> .....	<b>9</b>
<b>Pulse encoder interface</b> .....	<b>9</b>
<b>Plug-in fieldbus module</b> .....	<b>9</b>
<b>115/230V digital interface</b> .....	<b>9</b>
<b>External options</b>	
<b>Brake units and choppers</b> .....	<b>10</b>
<b>Technical data</b> .....	<b>11</b>
<b>Cooling</b> .....□	<b>11</b>
<b>Input cable and fuse connections</b> .....	<b>12</b>
<b>Technical specification</b> .....	<b>13</b>
<b>Control connections</b> .....	<b>14</b>
<b>ABB packaged drive with disconnect</b> .....	<b>16</b>
<b>Ratings, types and voltages</b> .....	<b>17</b>
<b>Dimensions</b> □	<b>18</b>

# ABB ACS550 standard drive

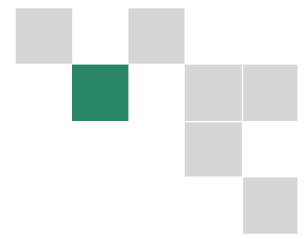

ACS550 - U1 - 03A3 - 4

## What is an ABB ACS550 standard drive?

The ABB ACS550 standard drive is simple to buy, install, configure and use, saving considerable time. The drive has common user and process interface with fieldbus, common software tools for sizing, commissioning, maintenance and common spare parts.

## Where can it be used?

The ABB ACS550 standard drive can be used in a wide range of industries. Typical applications include pump, fan and constant torque use, such as conveyors. The ABB ACS550 standard drive is ideal for those situations where there is a need for simplicity to install, commission and use and where customizing or special product engineering is not required.

## ABB ACS550 standard drive promises

- Quick delivery
- Easy installation
- Trouble-free start-up
- Intuitive operation

## Highlights:

- Advanced control panel permitting intuitive operation
- Patented swinging choke for superior harmonic reduction
- Sensorless vector control
- Integral RFI filter as standard
- Built-in Modbus and numerous internally mountable fieldbus adapters

## What are its main features?

Feature	Note	Benefit
Advanced control panel	Two soft-keys, functions change according to the state of the panel Built-in "Help" button Real-time clock, allows timed tracing of faults and setting of parameters to activate at various times of day Changed parameters menu	Easy commissioning Fast set-up Easier configuration Rapid fault diagnosis Quick access to recent parameter changes
Brake chopper	Built-in up to 15 Hp (480V & 600V) and up to 10Hp (230V)	Reduced installation cost
Chokes	Swinging chokes - matches the right inductance to the right load, suppressing and reducing harmonics	Reduces Total Harmonic Distortion (THD) emissions up to 25%
Connectivity	Simple to install: Easy connection of cables Easy connection to external fieldbus systems through multiple I/Os and plug-in options	Reduced installation time Secure cable connections
Diagnostic assistant	Activated when fault occurs	Quick fault diagnostics
EMC	Built-in RFI filters as standard	No need for additional external filtering
Fieldbus	Built-in Modbus using RS 485 Optional plug-in fieldbus modules	Reduced cost
Maintenance assistant	Monitors running hours or motor rotation	Takes care of preventative maintenance of drive, the motor or run application
Sensorless vector control	Improved motor control performance	Enables wider range of applications
Start-up assistant	Guides user through all essential settings without going to parameter list	Easy set-up of parameters
Switching frequency control	Permits the highest possible switching frequency based on operating and ambient conditions	Considerable motor noise reduction and improved efficiency

# Ratings, types and voltages

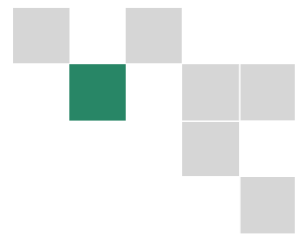

ACS550 - U1 - 03A3 - 4

## Type code

This is the unique reference number that clearly identifies the drive by mounting configuration, power rating and voltage. Once you have selected the type code, the frame size can be used to determine the drives dimensions, shown on the next page.

## Voltages

The ACS550 is available in three voltage ranges:

2 = 208 - 240V

4 = 380 - 480V

6 = 500 - 600V

## Notes

- $I_{2N}$ : continuous base current with 110% overload for 1 minute / 10 minutes.
- $I_{2hd}$ : continuous base current with 150% overload for 1 minute / 10 minutes.
- 180%  $I_{hd}$  continuous base current available for 2 seconds / 1 minute.
- The rated current of the ACS550 must be greater than or equal to the rated motor current to achieve the rated motor power given in the table.
- All -U1 models come with a conduit box and advanced control panel as standard.
- Horsepower is based on NEMA motor ratings for most 4-pole motors (1800 rpm). Check motor nameplate current for compatibility.
- All 230V product can be operated on 230V single-phase power, using a de-rate of the output current of 50%.
- All -U2 models come standard with US conduit openings, top entry / top exit, common mode filter for drives larger than 200 HP, fused disconnect and extended enclosure with advanced control panel.

Type Code UL Type 1 NEMA 1 <sup>(5,8)</sup>	Nominal Ratings				Frame Size
	Normal Duty (CT) (110% $I_{2N}$ )		Heavy-duty (CT) (150% $I_{2hd}$ )		
	$I_{2N}$ A <sup>(1,7)</sup>	P HP <sup>(4,6)</sup>	$I_{2hd}$ A <sup>(2,3,7)</sup>	P HP <sup>(4,6)</sup>	
ACS550-U1-04A6-2	4.6	1.0	3.5	0.75	R1
ACS550-U1-06A6-2	6.6	1.5	4.6	1.0	R1
ACS550-U1-07A5-2	7.5	2.0	6.6	1.5	R1
ACS550-U1-012A-2	11.8	3.0	7.5	2	R1
ACS550-U1-017A-2	16.7	5.0	11.8	3	R1
ACS550-U1-024A-2	24.2	7.5	16.7	5	R2
ACS550-U1-031A-2	30.8	10	24.2	7.5	R2
ACS550-U1-046A-2	46.2	15	30.8	10	R3
ACS550-U1-059A-2	59.4	20	46.2	15	R3
ACS550-U1-075A-2	74.8	25	59.4	20	R4
ACS550-U1-088A-2	88	30	74.8	25	R4
ACS550-U1-114A-2	114	40	88	30	R4
ACS550-U1-143A-2	143	50	114	40	R6
ACS550-U1-178A-2	178	60	143	50	R6
ACS550-U1-221A-2	221	75	178	60	R6
ACS550-U1-248A-2	248	100	192	75	R6
ACS550-U1-03A3-4	3.3	1.5	2.4	1	R1
ACS550-U1-04A1-4	4.1	2	3.3	1.5	R1
ACS550-U1-06A9-4	6.9	3	5.4	2	R1
ACS550-U1-08A8-4	8.8	5	6.9	3	R1
ACS550-U1-012A-4	11.9	7.5	8.8	5	R1
ACS550-U1-015A-4	15.4	10	11.9	7.5	R2
ACS550-U1-023A-4	23	15	15.4	10	R2
ACS550-U1-031A-4	31	20	23	15	R3
ACS550-U1-038A-4	38	25	31	20	R3
ACS550-U1-044A-4	44	30	38	25	R4
ACS550-U1-059A-4	59	40	44	30	R4
ACS550-U1-072A-4	72	50	59	40	R4
ACS550-U1-078A-4	77	60	65	50	R4
ACS550-U1-096A-4	96	75	77	60	R5
ACS550-U1-124A-4	124	100	96	75	R6
ACS550-U1-157A-4	157	125	124	100	R6
ACS550-U1-180A-4	180	150	156	125	R6
ACS550-U2-196A-4	196	150	162	125	R7
ACS550-U2-245A-4	245	200	192	150	R7
ACS550-U2-316A-4	316	250	248	200	R8
ACS550-U2-368A-4	368	300	302	250	R8
ACS550-U2-414A-4	414	350	368	300	R8
ACS550-U2-486A-4	486	400	414	350	R8
ACS550-U2-526A-4	526	450	477	400	R8
ACS550-U2-602A-4	602	500	515	450	R8
ACS550-U2-645A-4	645	550	590	500	R8
ACS550-U1-02A7-6	2.7	2	2.4	1.5	R2
ACS550-U1-03A9-6	3.9	3	2.7	2.0	R2
ACS550-U1-06A1-6	6.1	5	3.9	3.0	R2
ACS550-U1-09A0-6	9	7.5	6.1	5.0	R2
ACS550-U1-011A-6	11	10	9	7.5	R2
ACS550-U1-017A-6	17	15	11	10	R2
ACS550-U1-022A-6	22	20	17	15	R3
ACS550-U1-027A-6	27	25	22	20	R3
ACS550-U1-032A-6	32	30	27	25	R4
ACS550-U1-041A-6	41	40	32	30	R4
ACS550-U1-052A-6	52	50	41	40	R4
ACS550-U1-062A-6	62	60	52	50	R4
ACS550-U1-077A-6	77	75	62	60	R6
ACS550-U1-099A-6	99	100	77	75	R6
ACS550-U1-125A-6	125	125	99	100	R6
ACS550-U1-144A-6	144	150	125	125	R6

# Dimensions

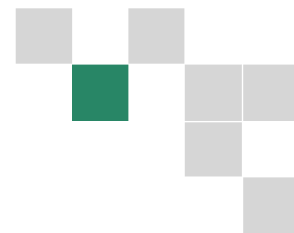

ACS550 - U1 - 03A3 - 4

## ACS550 R1 - R6 NEMA 1, UL Type 1, IP21

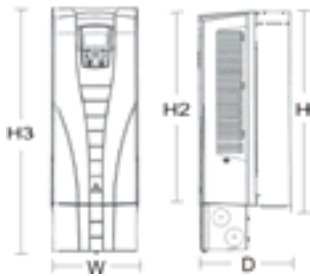

	R1		R2		R3		R4		R5		R6	
	mm	in	mm	in	mm	in	mm	in	mm	in	mm	in
W	125	4.9	125	4.9	203	8.0	203	8.0	267	10.5	302	11.9
H	330	13.0	430	16.9	490	19.3	596	23.4	602	23.7	700	27.6
H2	315	12.4	415	16.3	478	18.8	583	23.0	578	22.8	698	27.5
H3	369	14.5	469	18.5	583	23.0	689	27.1	736	29.0	880	34.6
D	212	8.3	222	8.7	231	9.1	262	10.3	286	11.3	400	15.8
	kg	lbs	kg	lbs	kg	lbs	kg	lbs	kg	lbs	kg	lbs
Weight	6.5	14.3	9.0	19.8	16.0	35.0	24.0	53.0	34.0	75.0	69.0	152.0

## ACS550 R1 - R6 NEMA 12, UL Type 12, IP54

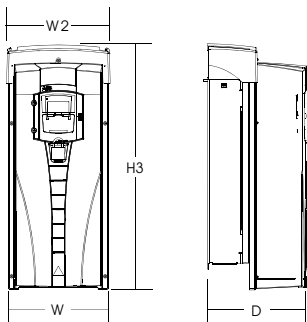

	R1		R2		R3		R4		R5		R6	
	mm	in	mm	in	mm	in	mm	in	mm	in	mm	in
W	213	8.4	213	8.4	257	10.1	257	10.1	369	14.5	410	16.1
W2	222	8.8	222	8.8	267	10.5	267	10.5	369	14.5	410	16.1
H3	461	18.1	561	22.1	629	24.8	760	29.9	773	30.4	926	36.5
D	234	9.2	245	9.6	253	10.1	284	11.1	309	12.2	423	16.6
	kg	lbs	kg	lbs	kg	lbs	kg	lbs	kg	lbs	kg	lbs
Weight	8.2	18.1	11.2	24.7	18.5	40.8	26.5	58.4	38.5	84.9	86.0	190.0

## ACS550 R7 - R8 NEMA 1, UL Type 1, IP 21

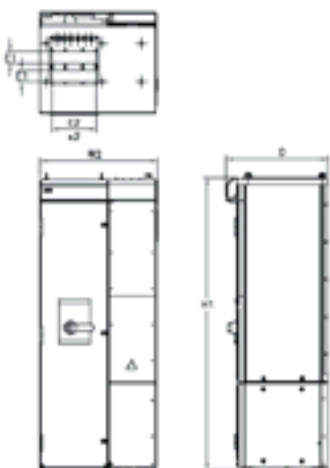

	R7		R8	
	mm	in	mm	in
H1	1503	59.17	2130	83.86
W2	609	23.98	800	31.5
D	495	19.49	585	23.03
E1	92	3.62	92	3.62
E2	250	9.84	250	9.84
	kg	lbs	kg	lbs
Weight	195	430	375	827

Drawings are not for engineering purposes.

# Construction

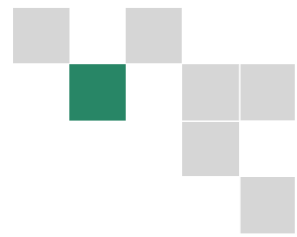

ACS550 - U1 - 03A3 - 4









“U1” within the type code (shown above) indicates the drive mounting configuration. U1 models are wall-mounted, while U2 models are free-standing with an extended enclosure and fused disconnect. Choose the correct one for your needs from the table below:

U1	U2
<ul style="list-style-type: none"> <li>■ Wall mounted, frame size R1-R6</li> <li>■ 0.75 - 150Hp</li> <li>■ UL Type 1 (IP21) NEMA 1</li> <li>■ Built-in EMC filter</li> <li>■ Standard software</li> <li>■ Built-in Modbus interface</li> <li>■ Cable connection box</li> <li>■ Brake chopper in frame sizes R1-R2</li> <li>■ Advanced control panel</li> </ul>	<ul style="list-style-type: none"> <li>■ Free standing, frame size R7-R8</li> <li>■ 150 - 550Hp</li> <li>■ UL Type 1 (IP21) NEMA 1</li> <li>■ Standard software</li> <li>■ Built-in Modbus interface</li> <li>■ Free-standing with extended enclosure and fused disconnect</li> <li>■ Advanced control panel</li> </ul>

## Advanced control panel

For easy drive programming, a detachable, multi-lingual alphanumeric advanced control panel is delivered as standard. The control panel has various assistants and a built-in help functions to guide the user. It includes a real time clock, which can be used during fault logging and in controlling

the drive, such as start/stop and maintenance reminders. The control panel can be used for copying parameters for back up or for downloading to another drive. A large graphical display and soft keys make it extremely easy to navigate.

	Name	Function
	Start	Initiates operation of drive
	Stop	Ceases operation of drive
	Up	Changes parameters and their value/ increases reference
	Down	Changes parameters and their value/ decreases reference
	Loc/Rem	Changes drive state from local control to remote control (I/O or other external source)
	HELP	Built-in “Help” button
	Soft key 1	Function changes according to state of panel
	Soft key 2	Function changes according to state of panel

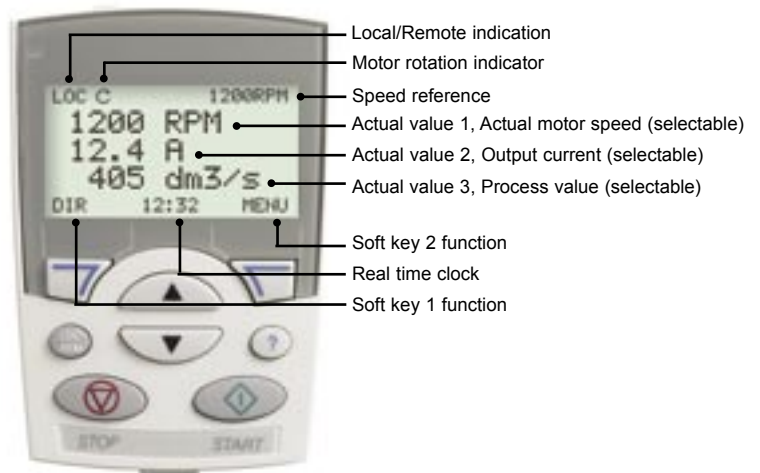

# Options

## Control interfaces

ACS550 - U1 - 03A3 - 4

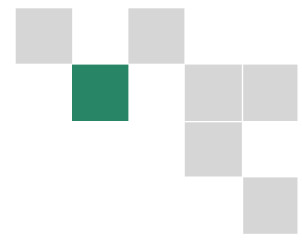

### How to select options

The options shown below are available for use with the ACS550. Each item has a 4-digit option code, which is shown in the table below. This code is added to the end of the type code above using a '+'. Ordering options using the option code provides a factory installed option, while using the description provides a field installable kit.

#### Available options

Option Code	Description	
<b>Protection class</b>		
B055	UL Type 12 (IP54) NEMA 12	
<b>Slot 1 Options</b>		
L511	Relay Output Extension	OREL-01
L502	Pulse Encoder Interface	OTAC-01
<b>Slot 2 Options</b>		
L512	115/230V Digital Interface	OHDI-01
K451	DeviceNet	RDNA-01
K454	Profibus-DP	RPBA-01
K462	ControlNet	RCNA-01
K466	EtherNet/IP and Modbus/TCP	RETA-01
K457	CANopen	RCAN-01

NOTE: Only one option can be installed in each option slot.

### Panel Mounting Kit

The panel mounting kit, ACS/H-CP-EXT, enables mounting of control panels on cabinet doors. This kit includes a 10 ft (3 m) extension cable, a gasket, mounting screws and a mounting template.

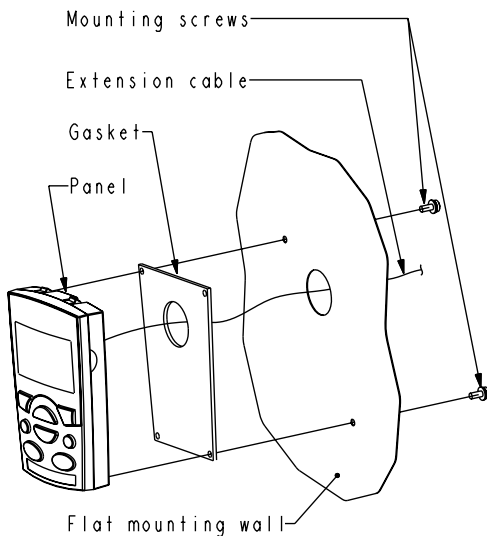

### DriveWindow Light 2

DriveWindow Light 2 is a PC software used for rapid commissioning, operating and programming of drives. It has features for programming, monitoring, troubleshooting and maintenance.

It is also a set-up and control tool which is Win98, WinNT, Win2000 and WinXP compatible.

DriveWindow Light 2 operates both off- and on-line. No additional PC hardware is required. It uses the PC's RS-232 port. It is also compatible with drive types ACS140, ACS160, ACS400, ACS600, ACS800 and DCS400.

#### DriveWindow Light 2 features

- Graphical start-up wizards
- Off- and on-line viewing and changing of drive parameters
- Backup and restore parameters. In a fault situation the parameters can be reloaded resulting in time savings
- Graphical monitoring of actual signal values
- I/O mapping table
- Control of the drive



# Options

## Plug-in options

ACS550 - U1 - 03A3 - 4

### Relay output extension module

This plug-in option offers three additional relay outputs. They can be used to actuate motor starters for pumps using a lead-lag alternation scheme with the built-in Pump-Fan Macro. All relays can be programmed to on/off by using the advanced control panel's clock. Alternatively, fieldbus adapters can be used to control any external components in the system.

### Pulse encoder interface

The Pulse Encoder Interface module offers a differential or single ended interface for a digital pulse encoder connection. The module is capable of operating from either a 15 or 24 VDC signal with a maximum frequency of 200kHz.

### 115/230V digital input interface

The 115/230V Digital Input Interface module offers six (6) 115/230V rated relays mounted on a common board used to drive DI1 through DI6 of the ACS550. The 115/230V must be provided by the user. The module cannot be used in conjunction with any fieldbus module as it occupies the same option slot.

### Plug-in fieldbus module

The plug-in fieldbus options bring connectivity to major automation systems. A single twisted pair avoids large amounts of conventional cabling, thereby reducing cost and increasing system reliability.

The ACS550 supports the following fieldbus options:

- DeviceNet
- Profibus-DP
- ControlNet
- EtherNet/IP and Modbus/TCP
- CANopen

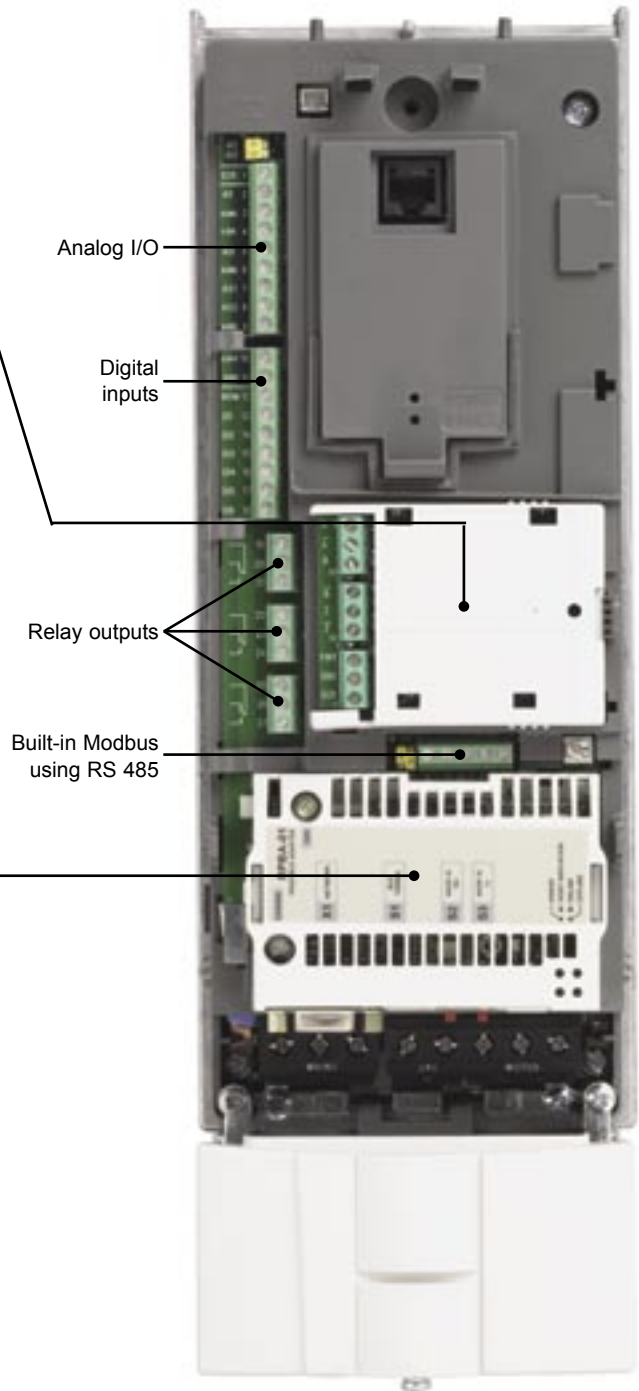

# Options

## External options

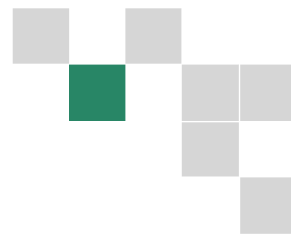

### Brake units and choppers

Frame sizes R1 to R2 are delivered with integrated brake choppers as standard. Other units can use the compact-sized brake units which include a brake chopper and resistor. For more information please refer to the ACS-BRK Brake Units Installation and Start-up Guide.

### Brake units technical data

Frequency Converter Input Voltage	Resistor Ohms	Continuous Output W	Max. Output 20/sec W	Brake Unit Type Code
200 - 240VAC 380 - 480VAC	32	2000	4500 12000	ACS-BRK-C
200 - 240VAC 380 - 480VAC	10.5	7000	14000 42000	ACS-BRK-D

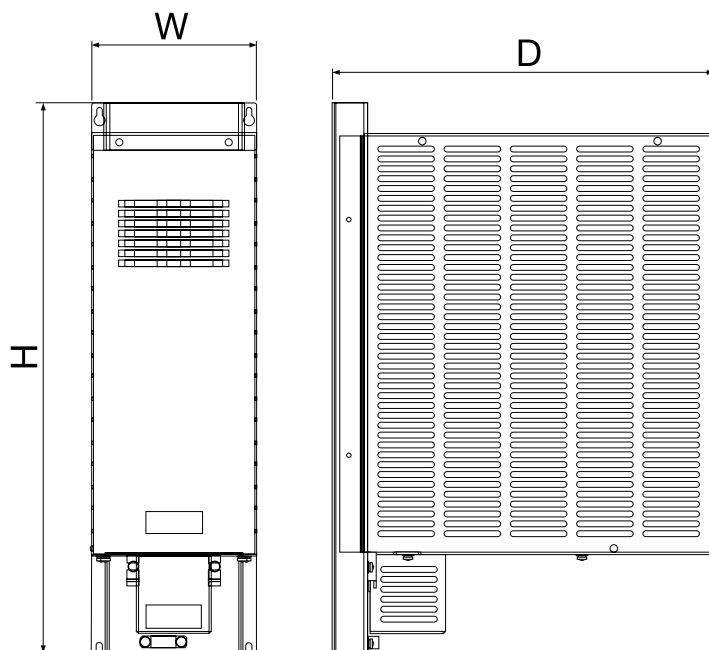

### Dimensions

Width (W) mm / in	Height (H) mm / in	Depth (D) mm / in	Weight (W) kg / lbs.	Brake Unit Type Code
150 / 5.9	500 / 19.7	347 / 13.7	7.5 / 16.5	ACS-BRK-C
270 / 10.6	600 / 23.6	450 / 17.7	20.5 / 45.1	ACS-BRK-D

# Technical Data

## Cooling

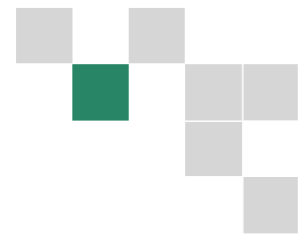

### Cooling Air Flow 208 - 240V Units

Type Code	Frame Size	W	BTU/Hr	m <sup>3</sup> /h	ft <sup>3</sup> /min
-04A6-2	R1	55	189	44	26
-06A6-2	R1	73	249	44	26
-07A5-2	R1	81	276	44	26
-012A-2	R1	116	404	44	26
-017A-2	R1	161	551	44	26
-024A-2	R2	227	776	88	52
-031A-2	R2	285	373	88	52
-046A-2	R3	420	1434	134	79
-059A-2	R3	536	1829	134	79
-075A-2	R4	671	2290	280	165
-088A-2	R4	786	2685	280	165
-114A-2	R4	1014	3463	280	165
-143A-2	R6	1268	4431	405	238
-178A-2	R6	1575	5379	405	238
-221A-2	R6	1952	6666	405	238
-248A-2	R6	2189	7474	405	238

### Cooling Air Flow 500 - 600V Units

Type Code	Frame Size	W	BTU/Hr	m <sup>3</sup> /h	ft <sup>3</sup> /min
-02A7-6	R2	46	157	88	52
-03A9-6	R2	68	232	88	52
-06A1-6	R2	124	423	88	52
-09A0-6	R2	170	581	88	52
-011A-6	R2	232	792	88	52
-017A-6	R2	337	1150	88	52
-022A-6	R3	457	1560	134	79
-027A-6	R3	562	1918	134	79
-032A-6	R4	667	2276	280	165
-041A-6	R4	907	3096	280	165
-052A-6	R4	1120	3820	280	165
-062A-6	R4	1295	4420	280	165
-077A-6	R6	1504	5136	405	238
-099A-6	R6	1821	6219	405	238
-125A-6	R6	2442	8339	405	238
-144A-6	R6	2813	9607	405	238

### Cooling Air Flow 380 - 480V Units

Type Code	Frame Size	W	BTU/Hr	m <sup>3</sup> /h	ft <sup>3</sup> /min
-03A3-4	R1	40	137	44	26
-04A1-4	R1	52	178	44	26
-06A9-4	R1	97	331	44	26
-08A8-4	R1	127	434	44	26
-012A-4	R1	172	587	44	26
-015A-4	R2	232	792	88	52
-023A-4	R2	337	1151	88	52
-031A-4	R3	457	1561	134	79
-038A-4	R3	562	1919	134	79
-044A-4	R4	667	2278	280	165
-059A-4	R4	907	3098	280	165
-072A-4	R4	1120	3825	280	165
-078A-4	R4	1300	4300	280	165
-096A-4	R5	1440	4918	250	147
-124A-4	R6	1940	6625	405	238
-157A-4	R6	2310	7889	405	238
-180A-4	R6	2810	9897	405	238
-196A-4	R7	3050	10416	540	318
-245A-4	R7	3850	13148	540	318
-316A-4	R8	4550	15539	1220	718
-368A-4	R8	6850	23394	1220	718
-414A-4	R8	7400	25000	1220	718
-486A-4	R8	7850	26809	1220	718
-526A-4	R8	7600	25955	1220	718
-602A-4	R8	8100	27663	1220	718
-645A-4	R8	9100	31078	1220	718

ACS550 are configured with cooling air fans. The cooling air must be free from corrosive materials with a maximum ambient temperature of 40°C (50°C with derating).

### Free space requirements

Enclosure Type	Space above mm / in	Space below mm / in	Space on left and right mm / in
U1 - Wall Mount	200 / 7.9	200 / 7.9	0
U2 - Floor Mount	200 / 7.9	0	0

# Technical data

## Fuse connections

Standard fuses can be used with ABB standard drives. For fuse connections see table below.

### Recommended input protection fuses

Type Code	Frame Size	Input Current A	Mains Fuses	
			IEC269 gG (A)	UL Class T (A)
-04A6-2	R1	4.6	10	10
-06A6-2	R1	6.6	10	10
-07A5-2	R1	7.5	10	10
-012A-2	R1	11.8	16	15
-017A-2	R1	16.7	25	25
-024A-2	R2	24.2	25	30
-031A-2	R2	30.8	40	40
-046A-2	R3	46.2	63	60
-059A-2	R3	59.4	63	80
-075A-2	R4	74.8	80	100
-088A-2	R4	88.0	100	110
-114A-2	R4	114.0	125	150
-143A-2	R6	143.0	200	200
-178A-2	R6	178.0	250	250
-221A-2	R6	221.0	315	300
-248A-2	R6	248.0	315	350
-03A3-4	R1	3.3	10	10
-04A1-4	R1	4.1	10	10
-06A9-4	R1	6.9	10	10
-08A8-4	R1	8.8	10	15
-012A-4	R1	11.9	16	15
-015A-4	R2	15.4	16	20
-023A-4	R2	23.0	25	30
-031A-4	R3	31.0	35	40
-038A-4	R3	38.0	50	50
-044A-4	R4	44.0	50	60
-059A-4	R4	59.0	63	80
-072A-4	R4	72.0	80	90
-078A-4	R5	77.0	80	100
-096A-4	R5	96.0	125	125
-124A-4	R6	124.0	160	175
-157A-4	R6	157.0	200	200
-180A-4	R6	180.0	250	250
-196A-4	R7	195.0	250	250
-245A-4	R7	245.0	250	250
-316A-4	R8	316.0	400	400
-368A-4	R8	368.0	400	400
-414A-4	R8	414.0	500	500
-486A-4	R8	486.0	500	500
-526A-4	R8	526.0	630	630
-602A-4	R8	602.0	630	630
-645A-4	R8	645.0	800	800
-02A7-6	R2	2.7	10	10
-03A9-6	R2	3.9	10	10
-06A1-6	R2	6.1	10	10
-09A0-6	R2	9.0	16	15
-011A-6	R2	11.0	16	15
-017A-6	R2	17.0	25	25
-022A-6	R3	22.0	25	25
-027A-6	R3	27.0	35	40
-032A-6	R4	32.0	35	40
-041A-6	R4	41.0	50	50
-052A-6	R4	52.0	60	60
-062A-6	R4	62.0	80	80
-077A-6	R6	77.0	80	100
-099A-6	R6	99.0	125	150
-125A-6	R6	125.0	160	175
-144A-6	R6	144.0	200	200

# Technical specification

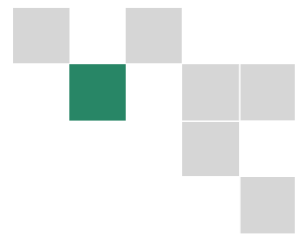

ACS550 - U1 - 03A3 - 4

Input power connection	
<b>Voltage and power range</b>	3-phase, 208 to 240 V, +10/-15%, 0.75 - 100Hp 3-phase, 380 to 480 V, +10/-15%, 1 - 550Hp 3-phase, 500 to 600V, +10/-15%, 1.5 - 150Hp
<b>Frequency</b>	48 to 63 Hz
<b>Power factor</b>	0.98

Motor connection	
<b>Voltage</b>	3-phase, from 0 to $U_{SUPPLY}$
<b>Frequency</b>	0 to 500 Hz
<b>Continuous loading capability</b> <small>(constant torque at a max ambient temperature of 40°C)</small>	Rated output current $I_2$
<b>Overload capacity</b> <small>(at a max. ambient temperature of 40°C)</small>	At normal use $1.1 \times I_{2N}$ for 1 minute every 10 minutes At heavy-duty use $1.5 \times I_{2nd}$ for 1 minute every 10 minutes Always $1.8 \times I_{2nd}$ for 2 seconds every 60 seconds
<b>Switching frequency</b>	Default 4 kHz
Standard	0.75 - 150Hp
Selectable	1 kHz, 4 kHz, 8 kHz, 12 kHz up to 550Hp 1 kHz, 4 kHz
<b>Acceleration time</b>	0.1 to 1800 s
<b>Deceleration time</b>	0.1 to 1800 s

Environmental limits	
<b>Ambient temperature</b>	-15 to 40°C (5 to 104°F) No frost allowed 40 to 50°C (104 to 122°F) $f_{switch}$ 4 kHz, $P_N$ and $I_2$ derated to 90%
<b>Altitude</b>	Output current Rated current available at 0 to 1000 m (3300 ft) reduced by 1% per 100 m over 1000 m (3300 ft) to 2000 m (6600 ft)
<b>Relative humidity</b>	lower than 95% (without condensation)
<b>Protection class</b>	UL Type 1 or 12 (NEMA 1 or NEMA 12)
<b>Enclosure color</b>	NCS 1502-Y, RAL 9002, PMS 420 C
<b>Contamination levels</b>	No conductive dust allowed
Transportation	IEC60721-3-1, class 2C2 (chemical gases), Class 2S2 (solid particles)
Storage	IEC60721-3-2, Class 1C2 (chemical gases), Class 1S2 (solid particles)
Operation	IEC60721-3-3, Class 3C2 (chemical gases), Class 3S2 (solid particles)

Programmable control connections	
<b>Two analog inputs</b>	
Voltage signal	0 (2) to 10 V, $R_{in} > 312 \text{ k}\Omega$ single-ended
Current signal	0 (4) to 20 mA, $R_{in} = 100 \Omega$ single-ended
Potentiometer reference value	10 V $\pm 2\%$ max. 10 mA, $R < 10 \text{ k}\Omega$
Maximum delay	12...32 ms
Resolution	0.1%
Accuracy	$\pm 1\%$
<b>Two analog outputs</b>	0 (4) to 20 mA, load $< 500 \Omega$
<b>Auxiliary voltage</b>	24 V DC $\pm 10\%$ , max. 250 mA
<b>Six digital inputs</b>	
12 V... 24 V DC with internal or external supply, PNP and NPN	
Input impedance	2.4 k $\Omega$
Maximum delay	5 ms $\pm 1$ ms
<b>Three relay outputs</b>	
Maximum switching voltage	250 V AC/30 V DC
Maximum switching current	6 A/30 V DC; 1500 V A/230 V AC
Maximum continuous current	2 A rms
<b>Serial communication</b>	
RS 485	Modbus protocol

Motor Control	
<b>Speed Control</b>	
Static Accuracy	20% of motor nominal slip
Dynamic Accuracy	$< 1\%$ sec with 100% torque step
<b>Motor Control</b>	
Torque Step Rise Time	$< 10$ ms with nominal torque
Non-Linearity	$\pm 5\%$ with nominal torque

Product compliance	
240V products:	UL, cUL, CSA and CE approvals
480V products:	UL, cUL, CSA and CE approvals
600V products:	UL, cUL, and CSA approvals
Quality assurance system ISO 9001 and Environmental system ISO 14001	

EMC (480V products, according to EN61800-3)	
1 <sup>st</sup> environment restricted distribution for frame sizes R3, R4 with 75 m motor cables and for frame sizes R1, R2, R5, R6 with 100 m motor cables.	
2 <sup>nd</sup> environment unrestricted distribution with 100 m cable as standard.	
For longer motor cable lengths, external EMC filters are available on request.	

# Control connections

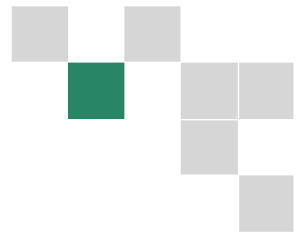

ACS550 - U1 - 03A3 - 4

These connections are shown as examples only.  
Please refer to the ACS550 User's Manual for more detailed information.

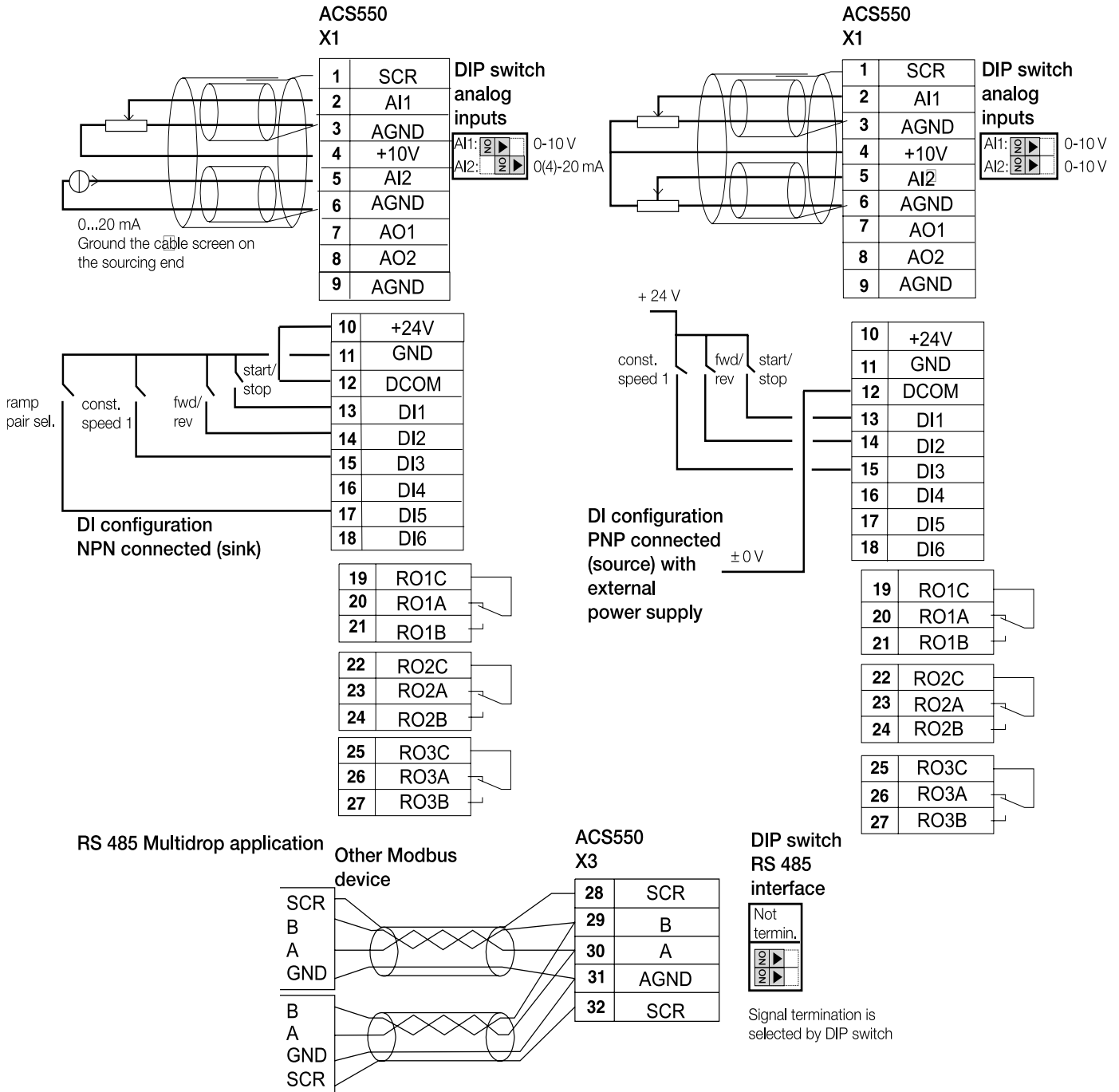

# Fieldbus Control

## Gateway to your process



ABB AC drives have the connectivity to major automation systems. This is achieved with a dedicated gateway concept between the fieldbus systems and ABB drives.

The fieldbus gateway is a snap-on module that can be easily mounted inside the drive. As a result of the wide range of fieldbus gateways, your choice for an automation system becomes independent of your decision to use first-class ABB AC drives.

### Manufacturing Flexibility

#### Drive control

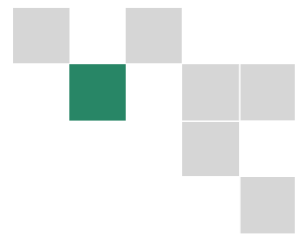
The drive Control Word (16 bit) provides a wide variety of functions from Start, Stop and Reset to Ramp Generator control. Typical setpoint values like Speed, Torque and Position can be transmitted to the drive with 15 bit accuracy.

#### Drive monitoring

A set of drive parameters and/or actual signals, like torque, speed, position, current etc., can be selected for cyclic data transfer providing fast data for operators and the manufacturing process.

#### Drive diagnostics

Accurate and reliable diagnostic information can be obtained via the drive Alarm, Limit and Fault Words reducing the down time of the drive and therefore also the down time of the manufacturing process.

#### Drive parameter handling

Total integration of the drives in the production process is achieved by single parameter read/write up to complete parameter set-up or download.

#### Easy to expand

Serial communication simplifies the latest trend of modular machine design enabling expansion of the installation at a later stage with low effort.

### Reduced Installation and Engineering Effort

#### Cabling

Substituting the large amount of conventional Drive Control cabling with a single twisted pair reduces costs and increases system reliability.

#### Design

The use of Fieldbus Control reduces engineering time at installation due to the modular structure of the hardware and software.

#### Commissioning and assembly

The modular machine configuration allows pre-commissioning of single machine sections and provides easy and fast assembly of the complete installation.

### Currently Available Gateways

- PROFIBUS-DP
- DeviceNet
- ControlNet
- EtherNet/IP and Modbus/TCP
- CANopen

# ABB ACS550 packaged drive with disconnect

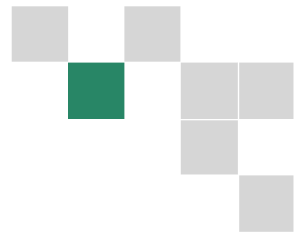

ACS550 - PC - 03A3 - 4

## ACS550 Packaged Drive

ACS550-PC and PD packaged drives combine the ACS550 AC drives with the disconnect arrangement of your choice in one coordinated, easy to install package. Packages are available with an input disconnect switch and fast acting, current limiting fuses (ACS550-PD) or an input circuit breaker (ACS550-PC) in NEMA 1 / UL Type 1 and NEMA12 / UL Type 12 enclosures. For easy drive programming and application monitoring, the multi-lingual, alphanumeric control panel is provided on the cover as standard. The control panel is detachable where it is desired to limit access.

## Vertical Wall Mount Enclosures

Available from 1 to 25 HP at 208/240V, 1 to 60 HP at 480V and 1.5 to 60 HP at 600V, this unique construction provides a minimum footprint advantageous for use in overcrowded electrical rooms or mezzanines, or for direct mounting on machines or columns. ACS550-PD versions are furnished with a disconnect switch and fast acting, current limiting drive input fuses and ACS550-PC versions include a circuit breaker disconnect means. Input and output conduit entry is at the bottom of the enclosure.



## Oversized Wall Mounting Enclosures

From 30 to 75 HP at 208/240V, 75 to 150 HP at 480V and 75 to 150 HP at 600V, wall mounting enclosures are sized to accommodate the field addition of components that users frequently desire to include at these higher horsepowers. Both ACS550-PD (disconnect switch) and ACS550-PC (circuit breaker) are furnished with fast acting, current limiting drive input fuses as standard. A removable conduit mounting plate is provided at the top of the enclosure.



## Free Standing Packages

From 200 HP to 550HP at 480V, ACS550-PC enclosures are free standing and will accommodate the field installation of additional components. Where additional enclosure panel space is required, an auxiliary enclosure section is available. A molded case circuit breaker provides the disconnect means function while fast acting, current limiting drive input fuses provide short circuit protection. A removable conduit mounting plate is provided at the top of the enclosure.





# Ratings, types and voltages

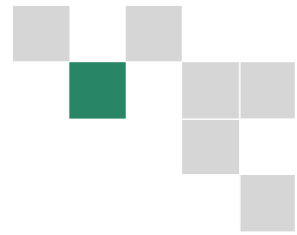

ACS550 - PC - 03A3 - 4

System Voltage	Type Code Drive with Circuit Breaker Disconnect NEMA Type 1 / UL Type 1	Type Code Drive W/ Disconnect Switch & Fuses NEMA Type 1 / UL Type 1	Nominal Ratings				Frame Size	NEMA 12 UL Type 12 Option Code
			Normal Duty (CT) (100% I2N)		Heavy-duty (CT) (150% I2hd)			
			$I_{2N}$ A <sup>(1)</sup>	$P_N$ HP	$I_{2hd}$ A <sup>(1)</sup>	$P_{hd}$ HP		
208/240 V	ACS550-PC-04A6-2	ACS550-PD-04A6-2	4.6	1	3.5	0.75	R1	+B055
	ACS550-PC-06A6-2	ACS550-PD-06A6-2	6.6	1.5	4.6	1	R1	+B055
	ACS550-PC-07A5-2	ACS550-PD-07A5-2	7.5	2	6.6	1.5	R1	+B055
	ACS550-PC-012A-2	ACS550-PD-012A-2	11.8	3	7.5	2	R1	+B055
	ACS550-PC-017A-2	ACS550-PD-017A-2	16.7	5	11.8	3	R1	+B055
	ACS550-PC-024A-2	ACS550-PD-024A-2	24.2	7.5	16.7	5	R2	+B055
	ACS550-PC-031A-2	ACS550-PD-031A-2	30.8	10	24.2	7.5	R2	+B055
	ACS550-PC-046A-2	ACS550-PD-046A-2	46.2	15	30.8	10	R3	+B055
	ACS550-PC-059A-2	ACS550-PD-059A-2	59.4	20	46.2	15	R3	+B055
	ACS550-PC-075A-2	ACS550-PD-075A-2	74.8	25	59.4	20	R4	+B055
	ACS550-PC-088A-2	ACS550-PD-088A-2	88	30	74.8	25	R4	+B055
	ACS550-PC-114A-2	ACS550-PD-114A-2	114	40	88	30	R4	+B055
	ACS550-PC-143A-2	ACS550-PD-143A-2	143	50	114	40	R6	+B055
	ACS550-PC-178A-2	ACS550-PD-178A-2	178	60	150	50	R6	+B055
ACS550-PC-221A-2	ACS550-PD-221A-2	221	75	178	60	R6	+B055	
ACS550-PC-248A-2	ACS550-PD-248A-2	248	100	192	75	R6	+B055	
480 V	ACS550-PC-03A3-4	ACS550-PD-03A3-4	3.3	1.5	2.4	1	R1	+B055
	ACS550-PC-04A1-4	ACS550-PD-04A1-4	4.1	2	3.3	1.5	R1	+B055
	ACS550-PC-06A9-4	ACS550-PD-06A9-4	6.9	3	5.4	2	R1	+B055
	ACS550-PC-08A8-4	ACS550-PD-08A8-4	8.8	5	6.9	3	R1	+B055
	ACS550-PC-012A-4	ACS550-PD-012A-4	11.9	7.5	8.8	5	R1	+B055
	ACS550-PC-015A-4	ACS550-PD-015A-4	15.4	10	11.9	7.5	R2	+B055
	ACS550-PC-023A-4	ACS550-PD-023A-4	23	15	15.4	10	R2	+B055
	ACS550-PC-031A-4	ACS550-PD-031A-4	31	20	23	15	R3	+B055
	ACS550-PC-038A-4	ACS550-PD-038A-4	38	25	31	20	R3	+B055
	ACS550-PC-044A-4	ACS550-PD-044A-4	44	30	38	25	R4	+B055
	ACS550-PC-059A-4	ACS550-PD-059A-4	59	40	44	30	R4	+B055
	ACS550-PC-072A-4	ACS550-PD-072A-4	72	50	59	40	R4	+B055
	ACS550-PC-078A-4	ACS550-PD-078A-4	77	60	65	50	R4	+B055
	ACS550-PC-096A-4	ACS550-PD-096A-4	96	75	77	60	R5	+B055
	ACS550-PC-124A-4	ACS550-PD-124A-4	124	100	96	75	R6	+B055
	ACS550-PC-157A-4	ACS550-PD-157A-4	157	125	124	100	R6	+B055
	ACS550-PC-180A-4	ACS550-PD-180A-4	180	150	156	125	R6	+B055
	ACS550-PC-245A-4	Use ACS550-PC	245	200	192	150	R7	+B055
	ACS550-PC-316A-4	Use ACS550-PC	316	250	240	200	R8	+B055
	ACS550-PC-368A-4	Use ACS550-PC	368	300	302	250	R8	+B055
ACS550-PC-414A-4	Use ACS550-PC	414	350	368	300	R8	+B055	
ACS550-PC-486A-4	Use ACS550-PC	486	400	414	350	R8	+B055	
ACS550-PC-526A-4+B055	Use ACS550-PC	526	450	477	400	R8	Standard	
ACS550-PC-602A-4+B055	Use ACS550-PC	602	500	515	450	R8	Standard	
ACS550-PC-645A-4+B055	Use ACS550-PC	645	550	590	500	R8	Standard	
600 V	ACS550-PC-02A7-6	ACS550-PD-02A7-6	2.7	2	2.4	1.5	R2	+B055
	ACS550-PC-03A9-6	ACS550-PD-03A9-6	3.9	3	2.7	2	R2	+B055
	ACS550-PC-06A1-6	ACS550-PD-06A1-6	6.1	5	3.9	3	R2	+B055
	ACS550-PC-09A0-6	ACS550-PD-09A0-6	9	7.5	6.1	5	R2	+B055
	ACS550-PC-011A-6	ACS550-PD-011A-6	11	10	9	7.5	R2	+B055
	ACS550-PC-017A-6	ACS550-PD-017A-6	17	15	11	10	R2	+B055
	ACS550-PC-022A-6	ACS550-PD-022A-6	22	20	17	15	R3	+B055
	ACS550-PC-027A-6	ACS550-PD-027A-6	27	25	22	20	R3	+B055
	ACS550-PC-032A-6	ACS550-PD-032A-6	32	30	27	25	R4	+B055
	ACS550-PC-041A-6	ACS550-PD-041A-6	41	40	32	30	R4	+B055
	ACS550-PC-052A-6	ACS550-PD-052A-6	52	50	41	40	R4	+B055
	ACS550-PC-062A-6	ACS550-PD-062A-6	62	60	52	50	R4	+B055
	ACS550-PC-077A-6	ACS550-PD-077A-6	77	75	62	60	R6	+B055
	ACS550-PC-099A-6	ACS550-PD-099A-6	99	100	77	75	R6	+B055
ACS550-PC-125A-6	ACS550-PD-125A-6	125	125	99	100	R6	+B055	
ACS550-PC-144A-6	ACS550-PD-144A-6	144	150	125	125	R6	+B055	

Frame R7 and R8 ACS550-PC packages include a circuit breaker disconnecting means and current limiting Class T drive input fuses.

(1) Refer to notes on page 5.

# Dimensions

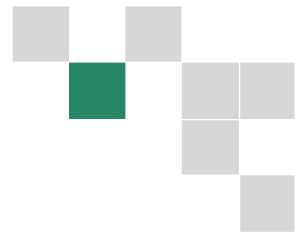

ACS550 - PC - 03A3 - 4

## ACS550- PC & PD R1-R8 NEMA Type 1, UL Type 1

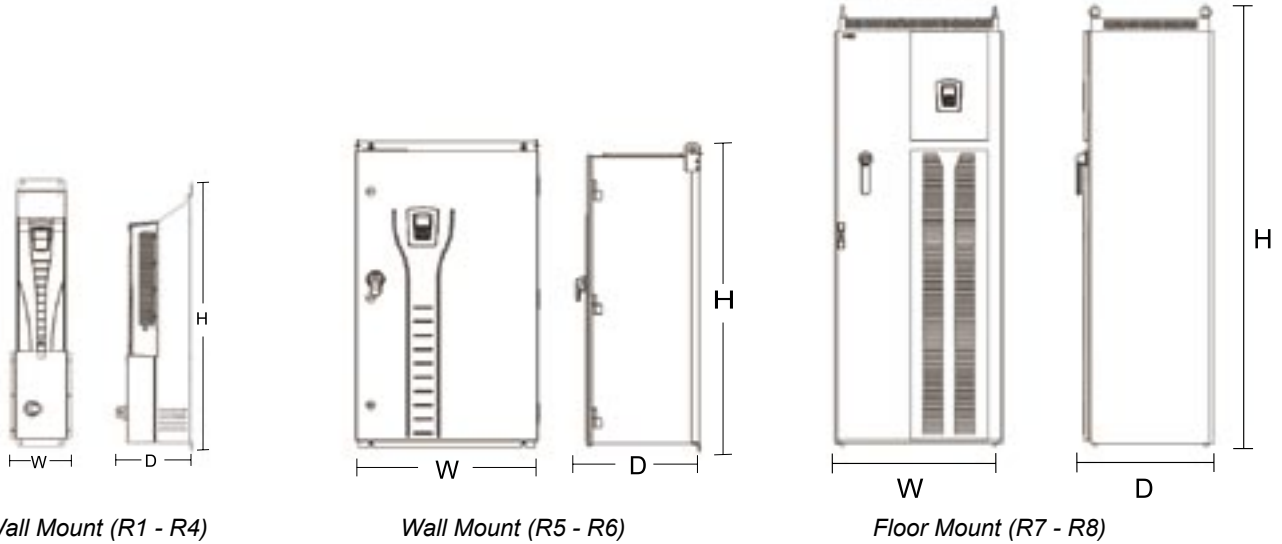

Frame Size	NEMA 1 Mounting Dimensions mm [inches]		NEMA 1 Dimensions and Weights mm      kg [inches] [lbs]			
	H1	W1	Height (H)	Width (W)	Depth (D)	Weight
R1	712 [28]	98 [3.9]	729 [28.7]	198 [7.8]	283 [11.2]	13 [28]
R2	812 [32]	98 [3.9]	829 [32.6]	198 [7.8]	295 [11.6]	17 [37]
R3	983 [38.7]	160 [6.3]	1013 [39.9]	260 [10.2]	304 [11.9]	45 [100]
R4	1117 [44]	160 [6.3]	1147 [45.2]	260 [10.2]	332 [13.1]	55 [121]
R5	1175 [46.3]	600 [23.6]	1212 [47.7]	713 [28.1]	485 [19.1]	121 [266]
R6	1175 [46.3]	600 [23.6]	1212 [47.7]	713 [28.1]	485 [19.1]	163 [360]
R7	Free Standing	Free Standing	2065 [81.3]	806 [31.7]	659 [25.9]	230 [506]
R8	Free Standing	Free Standing	2065 [81.3]	806 [31.7]	659 [25.9]	360 [793]

Drawings are not for engineering purposes.

# Dimensions

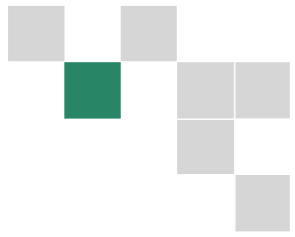

ACS550 - PC - 03A3 - 4

## ACS550- PC & PD R1-R8 NEMA Type 12, UL Type 12

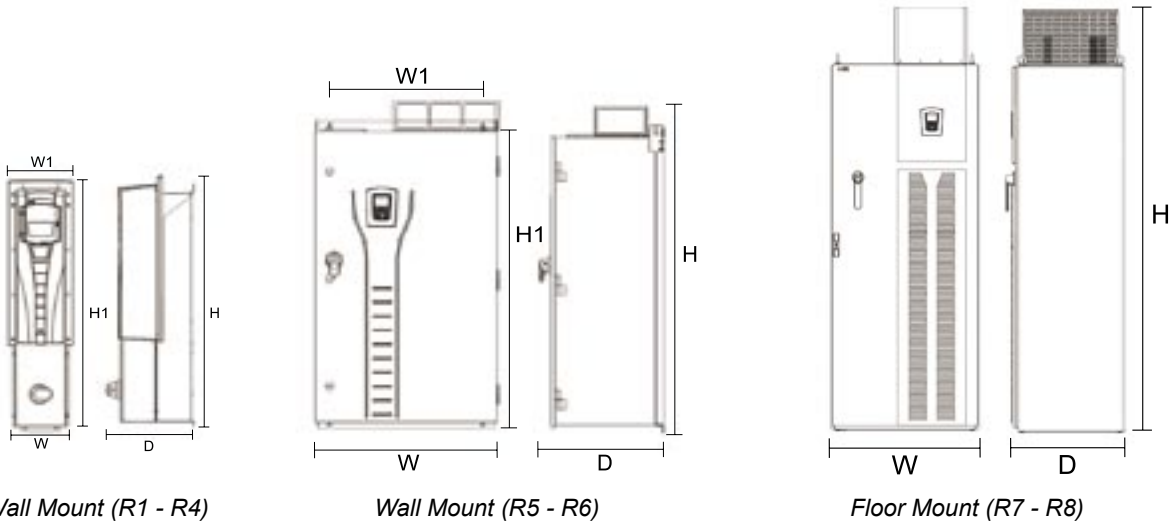

Frame Size	NEMA 12 Mounting Dimensions mm [inches]		NEMA 12 Dimensions and Weights mm kg [inches] [lbs]			
	H1	W1	Height (H)	Width (W)	Depth (D)	Weight
R1	712 [28]	98 [3.9]	744 [29.3]	222 [8.7]	283 [11.2]	15 [33]
R2	812 [32]	98 [3.9]	844 [33.2]	222 [8.7]	295 [11.6]	19 [42]
R3	983 [38.7]	160 [6.3]	1030 [40.6]	267 [10.5]	304 [11.9]	47 [103]
R4	1117 [44]	160 [6.3]	1163 [45.8]	267 [10.5]	332 [13.1]	57 [125]
R5	1175 [46.3]	600 [23.6]	1371 [54.0]	734 [28.9]	485 [19.1]	123 [271]
R6	1175 [46.3]	600 [23.6]	1371 [54.0]	734 [28.9]	484 [19.1]	166 [375]
R7	Free Standing	Free Standing	2377 [93.6]	806 [31.7]	659 [25.9]	250 [551]
R8	Free Standing	Free Standing	2377 [93.6]	806 [31.7]	659 [25.9]	380 [837]

Drawing is not for engineering purposes.

# The ABB Drives Product Family



## ACS50, ACS140 and ACS550 AC Drive Families

Includes the ACS50, ACS140 and ACS550 AC drives, covering sizes from ¼ hp to 550 hp and voltages from 110 to 600 V.



## ACS800 AC Drive Family

The ACS800 Single and Multi-Drive family includes drives from 0.75 hp to 3,000 hp and voltages from 230 to 690 V.



## Medium Voltage Drives

ABB's highly reliable ACS1000 is available from 400 hp to 6,700 hp and voltages of 2.3, 3.3, and 4.16 kV.



## DCS 400 and DCS 500 DC Drive Families

DCS 400 and DCS 500 DC Drives are available from 5 hp to 10,000 hp and voltages from 230 to 1,190 V.



## Low Voltage AC, DC and Medium Voltage AC Motors

Low-voltage AC motors from ABB range from ¼ hp to 800 hp and voltages from 208 to 480 V. A wide range of medium-voltage AC and low-voltage DC motors are also available.



## ABB Control

ABB provides the widest range of low voltage products and systems. Our broad product lines include high-quality solutions for industrial controls, circuit protection devices, starters & soft-starters, automation, and wire management & connection systems.



ACS550-PHTC01U-EN REV D Effective: 12/9/05 Specifications subject to change without notice.  
The Industrial™ wordmark and all above-mentioned product names in the form Drive™ are registered or pending trademarks of ABB.



ABB Inc.  
Low Voltage Drives  
16250 W. Glendale Drive  
New Berlin, WI 53151  
Telephone (800) 752-0696  
Fax (262) 785-0397  
Internet <http://www.abb.us/drives>

ABB Inc.  
Drives & LVC Canada  
3299 J.B. Deschamps Blvd.  
Lachine, Quebec  
H8T 3E4  
Telephone (800) 215-3006  
Fax (514) 420-3137  
Internet <http://www.abb.com/motors&drives>  
<http://www.abb-drives.com>